

 **Descripción/** Casita amueblada con mesa y ventanas-miradores.

- Materiales/**
- Estructura de Pino Rojo del Norte tratado en autoclave y acabada con lásur, protector de la madera a poro abierto, hidrófugo, fungicida y con doble filtro anti U.V.
 - Paneles de polietileno de alta densidad, libre de mantenimiento y antigraffiti, con decoración grabada.

 **Description/** Little house with table and windows.

- Materials/**
- P4 Vacuum pressure treated Pine wood structure, with open pore, waterproof, fungicide and ultraviolet radiation protection.
 - Maintenance-free, anti-graffiti, HDPE panels with engraved decoration.

 **Description/** Petite maison meublée avec table et fenêtres.

- Matériaux/**
- Structure en Pin du Nord Pin du Nord, traité en autoclave et finition lasurée, protecteur du bois à pores ouverts, hydrofuge, fongicide et avec double protection U.V.
 - Panneaux en polyéthylène haute densité, sans entretien et antigraffiti, décoration gravée.

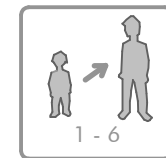
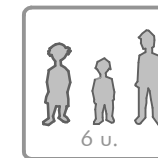
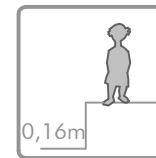

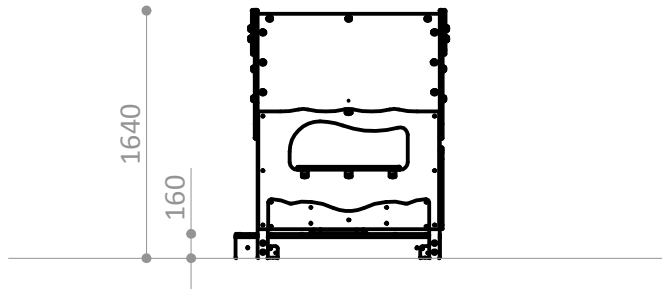

ESPACIO DE SEGURIDAD / ALTURA DE CAIDA A LIBRE
SAFETY AREA / FREE HEIGHT OF FALL
ZONE DE SECURITÉ / HAUTEUR DE CHUTE LIBRE

16,16 m² / 0,16 m

Superficie según EN-1176-1
Surface according to EN-1176-1
Revêtement conformément à la Norme EN-1176-1

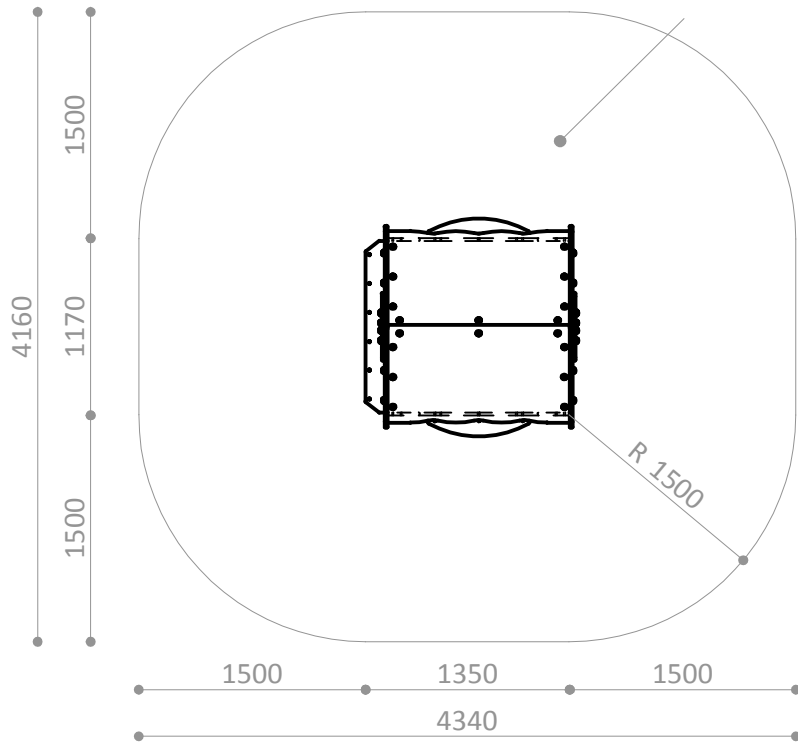

R5024 CASITA

Pieza más grande

Biggest part

La plus grande pièce

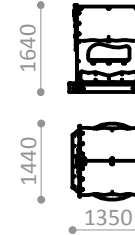

R5024 CASITA

Pieza más pesada

Heaviest part

La pièce la plus lourde

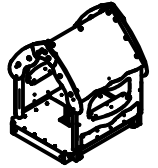

170 Kg.

R5024A

Suelo de hormigón

Concrete ground

Fixation sur béton

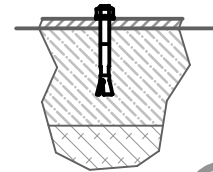

x4

R5024E

Otros suelos

Other grounds

Autres sols

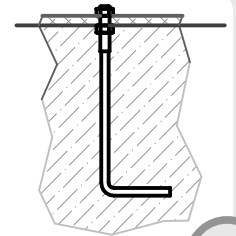

x4

Disponibilidad de repuestos durante 10 años.
Spare parts available for 10 years.
Disponibilité de pièces de rechange pendant 10 ans.

Industrias Agapito se reserva el derecho a modificar sin previo aviso los elementos descritos en este documento.
Industrias Agapito reserves the right to change the items described in this document without prior notice.
Industrias Agapito se réserve le droit de modifier à tout moment et sans préavis les éléments décrits dans le présent document.

