**R4864A**

Suelo de hormigón
 Concrete ground
 Fixation sur béton

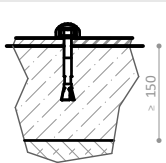

x2

R4864E

Otros suelos
 Other grounds
 Autres sols

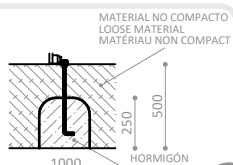

x2

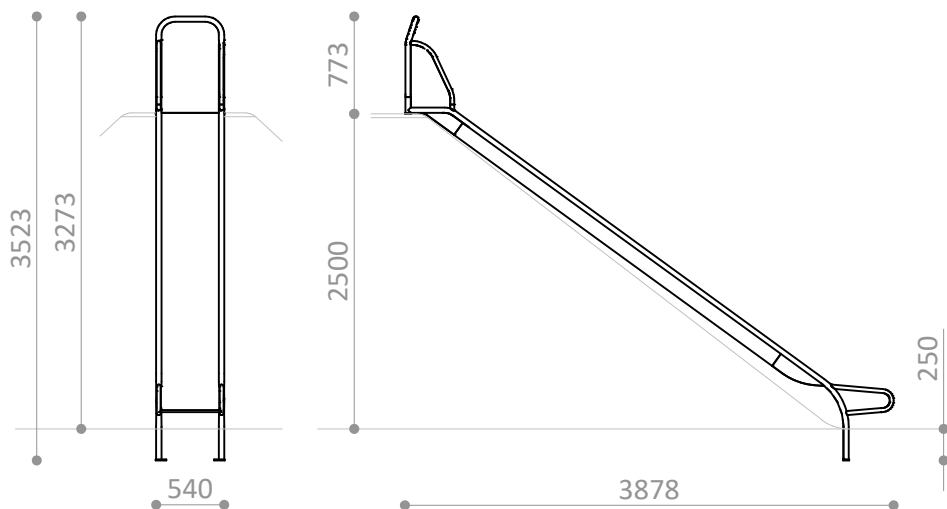

ÁREA DE IMPACTO / ALTURA DE CAÍDA LIBRE
 IMPACT ZONE / FREE HEIGHT OF FALL
 ZONE D'IMPACT / HAUTEUR DE CHUTE LIBRE

A - 2,19 m² / 0,00 m
 B - 13,60 m² / 2,50 m
TOTAL = 15,79 m²

Superficie según EN 1176
 Surface according to EN 1176
 Revêtement conformément à la Norme EN 1176

PIEZA MÁS GRANDE
 BIGGEST PART
 LA PLUS GRANDE PIÈCE
3523 x 3878 x 540 mm

PIEZA MÁS PESADA
 HEAVIEST PART
 LA PIÈCE LA PLUS LOURDE
84 Kg

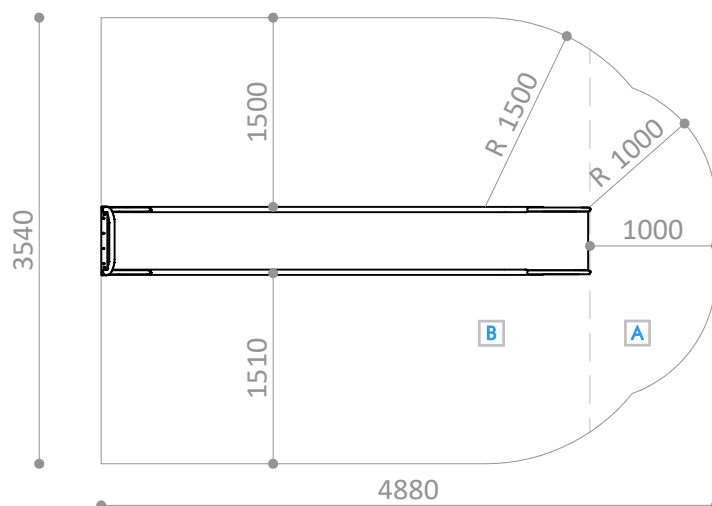



Descripción/ Tobogán ladera de acero inoxidable.

Materiales/

- Pista y estructura de acero inoxidable.

Description/ Stainless steel slide.



Materials/

- Stainless steel structure and ramp slide.

Description/ Glissière en inox.



Matériaux/

- Piste et structure en acier inoxydable.

Disponibilidad de repuestos durante 10 años.

Spare parts available for 10 years.

Disponibilité de pièces de rechange pendant 10 ans.

Industrias Agapito se reserva el derecho a modificar sin previo aviso los elementos descritos en este documento.

Industrias Agapito reserves the right to change the items described in this document without prior notice.

Industrias Agapito se réserve le droit de modifier à tout moment et sans préavis les éléments décrits dans le présent document.

