



Descripción/ Multijuego con 3 torres, 2 de ellas de 3m de altura con tejado.
Juegos adicionales: Red de trepa, rampa curvada, paso de cuerdas, rocódromo, tobogán de barras de deslizamiento, puente colgante, tobogán de acero inoxidable, escalerilla de acceso y asiento de tertulia.

- Materiales/**
- Pino Rojo del Norte, tratada en autoclave a nivel P4 y acabada con lásur, protector de la madera a poro abierto, hidrófugo, fungicida y con doble filtro anti U.V.
 - Polietileno de alta densidad, de 2 cm de espesor, libre de mantenimiento y antigraffiti.
 - Rampas y puentes en polietileno revestido de caucho antideslizante.
 - Redes de polipropileno con alma de acero.
 - Partes metálicas de acero inoxidable, acero galvanizado y acero con pintura de poliéster termoendurecida.



Description/ Playset with 3 towers, 2 of them 3m high with a roof.
Additional games: Climbing net, curved ramp, rope bridge, climbing wall, sliding bar with bar slide, moving bridge, stainless steel slide, stairs and conversation sit.

- Materials/**
- P4 Vacuum pressure treated Pine wood structure, with open pore, waterproof, fungicide and ultraviolet radiation lasur protection. 2 cm thick, anti-graffiti, maintenance free HDPE.
 - Rubber covered HDPE in ramps and bridges
 - Steel- core polypropylene nets.
 - Stainless, thermohardened polyester painted galvanized steel metal parts.



Description/ Structure multijeu avec 3 tours, dont deux de 3m de hauteur avec toit.
Jeux additionnels : Filet sur poteau, rampe courbe, pont de cordes, mur d'escalade, toboggan barre de glissement avec dossier, pont suspendu, toboggan en acier inoxydable, escalier et point de rencontre.

- Matériaux/**
- Structure en Pin du Nord, traité en autoclave et finition lasurée, protecteur du bois à pores ouverts, hydrofuge, fongicide et avec double protection U.V.
 - Polyéthylène haute densité de 2 cm d'épaisseur, libre d'entretien et antigraffiti.
 - Rampes et ponts revêtus de caoutchouc antidérapant.
 - Filets en polypropylène avec âme en acier.
 - Pièces métalliques en acier inoxydable, acier galvanisé et acier avec peinture polyester thermodurcie.

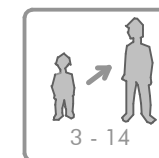
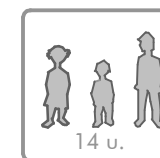
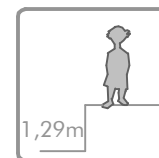

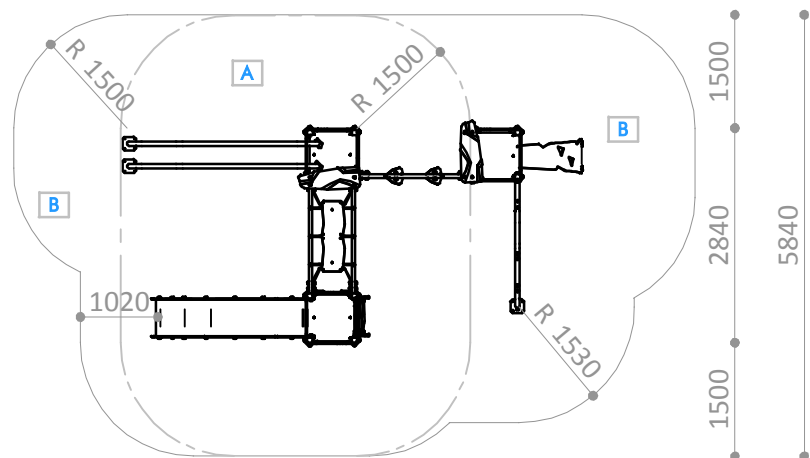
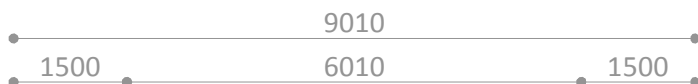
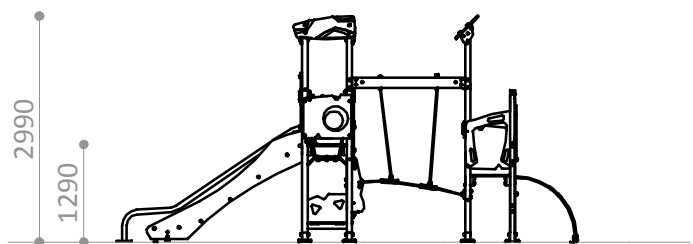

ESPACIO DE SEGURIDAD / ALTURA DE CAIDA LIBRE
SAFETY AREA / FREE HEIGHT OF FALL
ZONE DE SECURITÉ / HAUTEUR DE CHUTE LIBRE

A - 25 m2 / 1,29m
B - 20 m2 / 1 m

Superficie según EN-1176-1
Surface according to EN-1176-1
Revêtement conformément à la Norme EN-1176-1

R4220-02

Pieza más grande

Biggest part

La plus grande pièce

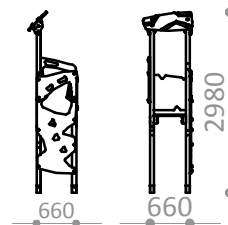

R4220-02

Pieza más pesada

Heaviest part

La pièce la plus lourde



R4220XA

Suelo de hormigón

Concrete ground

Fixation sur béton

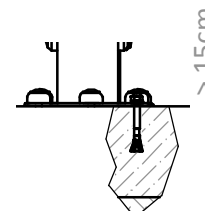

x64

R4220XE

Otros suelos

Other grounds

Autres sols

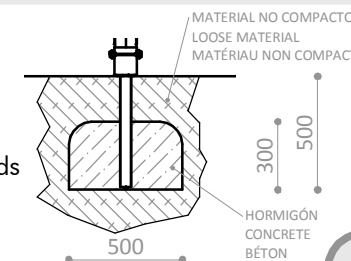

x19

Disponibilidad de repuestos durante 10 años.
Spare parts available for 10 years.
Disponibilité de pièces de rechange pendant 10 ans.

Industrias Agapito se reserva el derecho a modificar sin previo aviso los elementos descritos en este documento.
Industrias Agapito reserves the right to change the items described in this document without prior notice.
Industrias Agapito se réserve le droit de modifier à tout moment et sans préavis les éléments décrits dans le présent document.



R4220X

MULTIJUEGO VELETA TRIPLE
TRIPLE VELETA PLAYSET
STRUCTURE MULTI-JEUX VELETA TRIPLE

FICHA TECNICA
TECHNICAL SHEET
FICHE TECHNIQUE
FT-R4220Xrev04 - 3/4



