

 **Descripción/** Moderna estructura antivandálica formada por: 3 accesos para trepar, un acceso de red de propileno con alma de acero y tobogán de polietileno.

- Materiales/**
- Estructura de acero con pintura de poliéster termo endurecida.
 - Paneles de polietileno de alta densidad, de 2 cm de espesor, libre de mantenimiento y antigraffiti, con decoración grabada.

 **Description/** Antivandalic modern structure with several games: Three climbing access, polyethylene slide and polypropylene with steel core ladder climbing access.

- Materials/**
- Thermohardened polyester painted steel structure.
 - Maintenance-free, anti-graffiti, 2 cm thick HDPE panels with engraved decoration

 **Description/** Très moderne structure anti vandalisme. Jeux y compris: 3 arcs à grimper, filet de cordes en polyéthylène âme acier et un toboggan en polyéthylène.

- Matériaux/**
- Structure en acier avec peinture polyester thermodurcie.
 - Panneaux en polyéthylène haute densité de 2cm d'épaisseur, sans entretien et antigraffiti, décoration gravée.

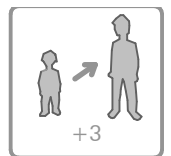
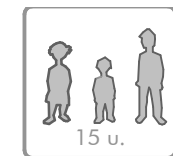
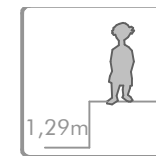

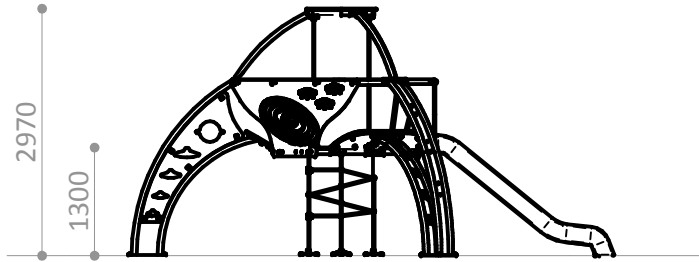

ESPACIO DE SEGURIDAD / ALTURA DE CAIDA LIBRE
SAFETY AREA / FREE HEIGHT OF FALL
ZONE DE SECURITÉ / HAUTEUR DE CHUTE LIBRE

A - 37 m² / 1,3 m
B - 5 m² / 1 m

Superficie según EN-1176-1
Surface according to EN-1176-1
Revêtement conformément à la Norme EN-1176-1

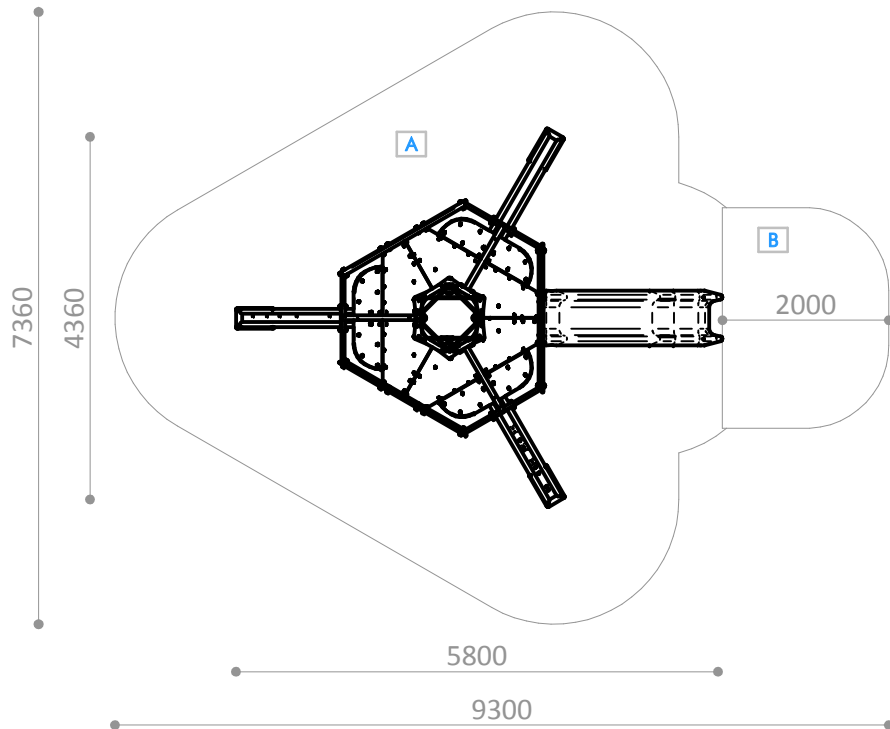

R4270-03 SUELO

Pieza mas grande

Biggest part

La plus grande pièce

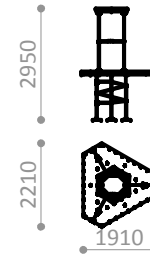

R4270-03 SUELO

Pieza mas pesada

Heaviest part

La pièce la plus lourde

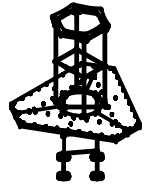

131 Kg.

R4270PA

Suelo de hormigón

Concrete ground

Fixation sur béton

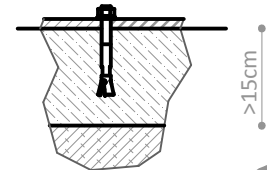

x30

R4270PE

Otros suelos

Other grounds

Autres sols

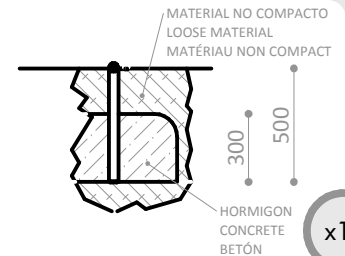

x12

R4270PE

Otros suelos

Other grounds

Autres sols

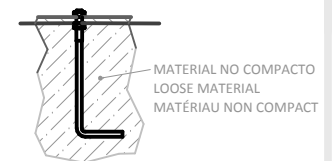

x18

Disponibilidad de repuestos durante 10 años.
Spare parts available for 10 years.
Disponibilité de pièces de rechange pendant 10 ans.

Industrias Agapito se reserva el derecho a modificar sin previo aviso los elementos descritos en este documento.
Industrias Agapito reserves the right to change the items described in this document without prior notice.
Industrias Agapito se réserve le droit de modifier à tout moment et sans préavis les éléments décrits dans le présent document.

